

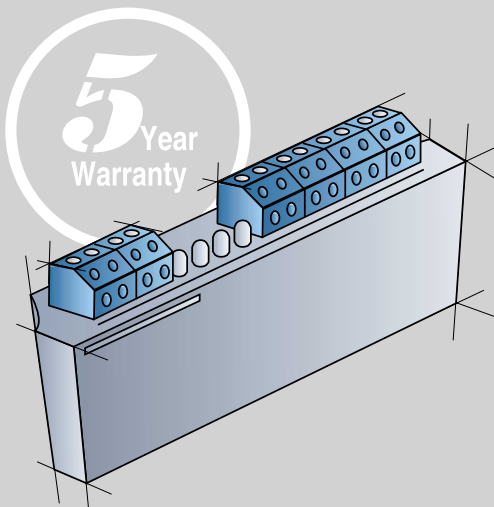

MagPAC Modular Sensors
Bifurcated Reed Switches
with LED Indication

MAGNUM
High-current Hermetically Sealed
Proximity Sensors.

MagPAC Modular Sensors



AccuTrak™ 9000

All Classes & Groups

By applying the economic advantages offered by the National Electrical Code, and by utilization of hermetically sealed MagPAC and Magnum sensors, the AccuTrak 9000 merges technology with economy. Cost saving benefits are realized by the consolidation of components and the complete elimination of hazardous location seal fittings, wiring, conduit and their associated labor costs.

MagPAC™ & Magnum™

These proximity sensors were designed in response to our customers needs. The main requirement for any product in a process plant is reliability. That is why the MagPAC and Magnum sensors are warranted to perform as specified for a full five years. This warranty reflects our complete confidence in the capabilities of our product.

Corrosion Resistance

The MagPAC and Magnum switch contacts are hermetically sealed in an inert atmosphere to protect them from dust, oxidation or external corrosion. The entire sealed unit is then encapsulated in an epoxy resin to cushion the sensor in case of shock or vibration. The encapsulation process renders the sensor impervious to moisture, chemicals and solvents.

Low Power and/or High Capacitance Applications

The MagPAC has been specifically designed for use in low power ($P \leq 240 \text{ mW}$) and high DI card capacitance ($C \geq 0.01 \text{ mfd}$) discrete position feedback applications. The bifurcated switch design creates a self cleaning snap action movement that prevents contact oxide buildup and breaks non-resistive loads. With all the advantages of a solid state sensor and with zero leakage current the MagPAC is the sensor of choice.



AccuTrak™ 9000

Technical Specifications

MagPAC Sensors

MagPAC sensors are designed for capacitive, high and low switching capacity on capacitive, inductive and resistive loads while offering excellent performance for low current applications.

The hermetically sealed elements form a compact modular unit that affords interchangeability with other Westlock monitors. Ultra bright LED's provide positive indication in the field for coil status and valve position.

Specifically designed for heavy duty applications, where superior performance and high reliability are a must. The MagPAC clearly sets the standard for new sensor technology desired in industrial applications.



Magnum Sensors

The Magnum sensor was developed specifically for valve monitoring applications. The Form C, SPDT contacts are manufactured from solid hunks of pure tungsten. Since tungsten has the highest melting point of all metals plus excellent electrical conductivity characteristics, the Magnum proximity sensor is capable of handling 3 amps (switching) at 120 VAC and 2 amps (switching) at 24 VDC. The sensor is UL listed and CSA recognized.

COMPARATIVE COST ANALYSIS

Merging Technology with Economy

UL/CSA Listed Valve Position Monitors for NEMA 4, 4X, 7, 9; Class 1, Groups C, D, Class II, Groups E, F & G, Div. 1 & 2

ROTARY VALVE	CONVENTIONAL METHOD		WESTLOCK
	MECHANICAL SWITCHES	PROXIMITY SWITCHES	MAGNUM® SENSORS
2 switches w/ bracketry	\$150	\$358	\$338
solenoid	\$100	\$100	\$100
junction box	\$50	\$50	N/R*
seal fittings	\$40	\$80	N/R*
wire, conduit	\$20	\$30	N/R*
labor	\$170	\$270	N/R*
TOTAL COST	\$530	\$888	\$438
TOTAL COST (250 Valves)	\$132,500	\$222,000	\$109,500

LINEAR CONTROL VALVE	CONVENTIONAL METHOD		WESTLOCK
	MECHANICAL SWITCHES	PROXIMITY SWITCHES	MAGNUM® SENSORS
2 switches w/ bracketry	\$550	\$630	\$480
solenoid	\$100	\$100	\$100
junction box	\$50	\$50	N/R*
seal fittings	\$40	\$80	N/R*
wire, conduit	\$20	\$30	N/R*
labor	\$170	\$270	N/R*
TOTAL COST	\$830	\$1160	\$580
TOTAL COST (250 Valves)	\$207,500	\$290,000	\$145,000

*Not Required
Solenoid: Asco 8320A90
Comparative costs were based upon list prices from major manufacturers.

NATIONAL ELECTRICAL CODE (1999):

Article 501-5(a) & (b). Conduit Seals, Class I, Div. 1 & 2

In each conduit run entering an enclosure for switches which may produce arcs, seals shall be placed no more than 18 inches from such enclosures.

Exception: Conduit runs 1 1/2 inches and smaller entering an explosion-proof enclosure for switches need not be sealed if the current-interrupting contacts are enclosed within a chamber hermetically sealed against the entrance of gases or vapors.

NOTE: Note: For conformance to UL and CSA requirements, all conduit runs in Class I, Division 1 hazardous locations must have a sealing fitting connected within 18 inches of the enclosure.

AccuTrak™ 9000

Technical Specifications

MagPac™ Modular Sensors

Bifurcated Reed Proximity Sensor, SPST • (Hermetically Sealed) FM, CSA

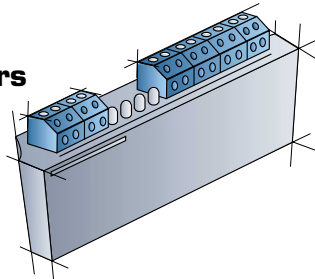

Technical Data	
Contact Arrangement	(2) SPST, Form A (Normally Open)
Contact Material	Movable Contact - Silver Cadmium Oxide Stationary Contact-Molybdenum
Operating Time	≤ 4ms
Releasing Time	≤ 2ms
Initial Contact Resistance	≤ 250 milliohms
Seal	Hermetic
Approvals	CSA, FM
Operating Temperature	-40°C - 85°C
Operational Life	100,000,000 Operations
Repeatability	.125 mm
Warranty	5 Years
Protection Class	That of associated enclosure, typically NEMA 4, 4X
Electrical Rating	
Rated Voltage	12 - 120 VAC/VDC
Rated Current	Min. - 2 mA to light LED, Max. - 750 mA
Allowable Sol. Coil Input Vol.	25 - 120 VAC/VDC

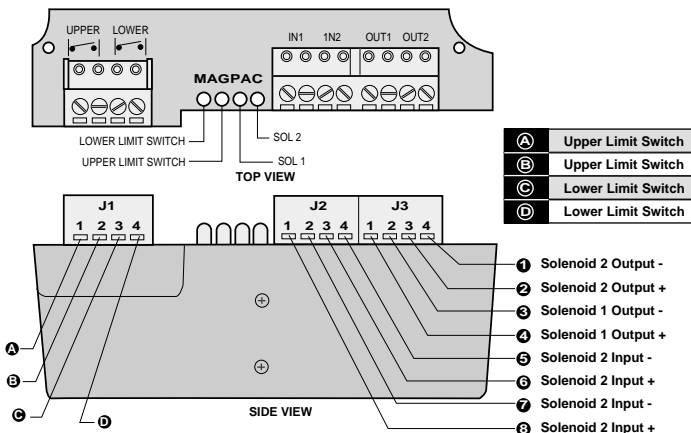

Magnum™ XT-90

Hermetically Sealed Proximity Sensor

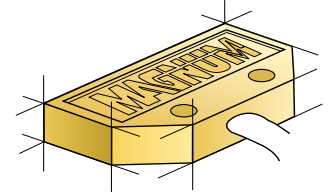

Technical Data	
Contact Arrangement	SPST/SPDT, Form C (Normally Open)
Contacts	Pure Tungsten
Operating Time	3.0 m Sec.
Initial Contact Resistance	.50 ohms (Max)
Seal	Hermetic
Housing (Flame Retardant)	High Impact Valox®
Approvals	UL, CSA
Temperature Range	-40°F to +185°F
Operational Life	600,000 Cycles (full rated load)
Repeatability	.125 mm.
Warranty	5 Years
Protection Class	IP 67

Electrical Rating

Rhodium	SPST/SPDT Form C (Normally Open) 0.295 amps/120 VAC, 0.15 amps/240 VAC, 1 amp/24 VDC
Tungsten	SPST/SPDT Form C (Normally Open) 3 amps/120 VAC, 1.5 amps/240 VAC, 2 amps/24 VDC



Magnum and Proximity Sensors Only

For low power (P ≤ 240 mW) and/or high DI card capacitance (C ≥ 0.01 mfd.) applications refer to the Reference Section Bulletin No. WD-13.02 or specify the MagPAC sensor module.

0-100% Position Transmission

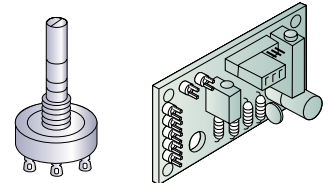

Resistive Output Signal

Standard Output Signal	1000 ohms
Power Rating at 70°C	1 watt
Elements	Conductive Plastic
Rotational Life (no load)	100,000 cycles

Current Output Signal

Standard Output Signal	4-20 mADC, 2 wire
Power Requirements	6.5-33 VDC
Max. Load Resistance at 24 VDC	950 ohms
Operating Temperature	-40°C to 85°C

Area Classifications

9044
NEMA 4, 4x



9358
NEMA 4, 4x

9468
NEMA 4, 4X Nonincendive
Class I, Groups A, B, C, D
Class II, Groups F, G, Division 2 only
FM, CSA



9479
NEMA 4, 4X, 7, 9
Class I, Groups C, D
Class II, Groups E, F, G, Division 1 & 2
Class I Groups A, B, Division 2
FM, UL, CSA









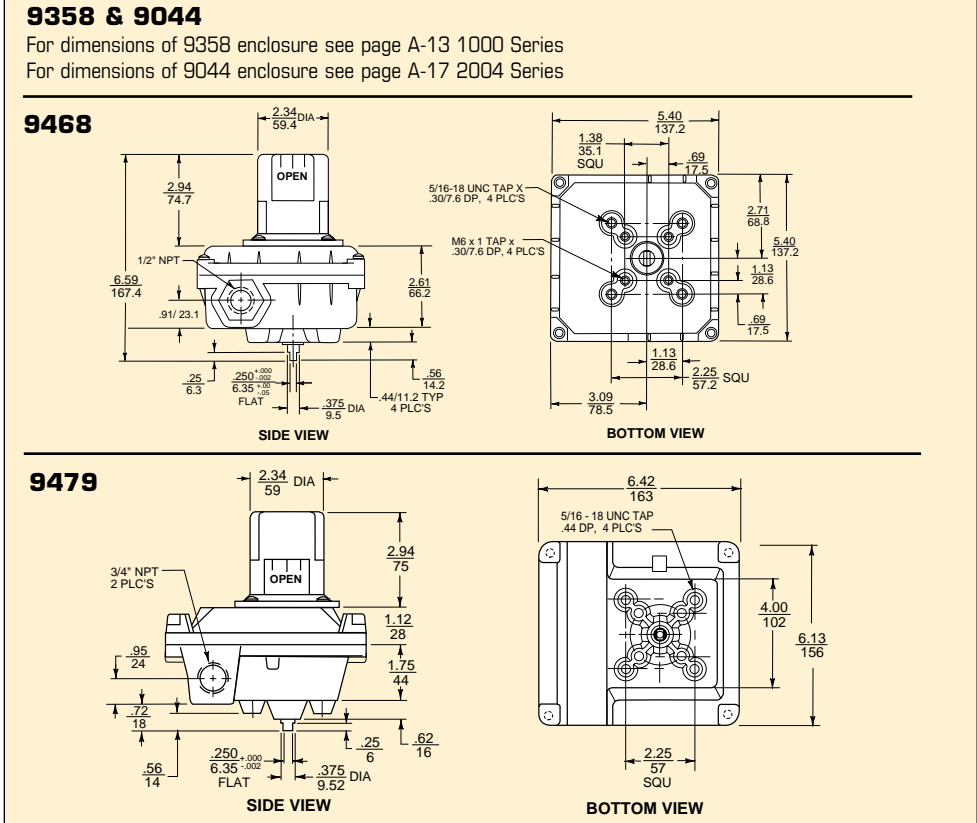

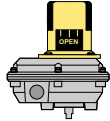

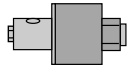

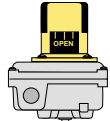

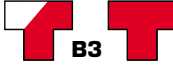

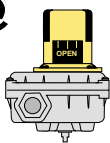
AccuTrak™ 9000

DIMENSIONS (inches/mm)

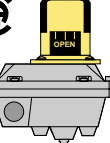
9358 ENCLOSURE	
Enclosure	Engineered Resin Clear Cover optional
Conduit Entries	2 - 1/2"
Terminal Strip	8 point standard 12 points optional
9044 ENCLOSURE	
Enclosure	Die Cast Aluminum
Conduit Entries	2 - 1/2", optional 3-1/2"
Terminal Strip	8 point standard 12 points optional
9468 ENCLOSURE	
Enclosure	Engineered Resin Clear Cover optional
Conduit Entries	2 - 1/2" optional 3-3/4"
Terminal Strip	8 point standard 16 points optional
Sensors	up to 4
9479 ENCLOSURE	
Enclosure	Die Cast Aluminum
Conduit Entries	2 - 3/4" optional 4-3/4"
Terminal Strip	8 point standard 16 points optional
Sensors	up to 4

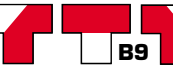

SERIES II (Magnum Sensors)	BEACON™	3-WAY BEACON™	TRANSMITTERS	SOLENOID
9358 Engineered Resin NEMA 4, 4X CSA  	STANDARD (Black & Yellow) BY 	90° Rotation  B1	Resistive Output: 1000 ohms RS (Approvals for: Nema 4, 4X General Purpose Only unless in 9479 enclosure) Current Output: 4-20 mA CS Spectrum: 4-20 mA DT (9479 only)	To Be Specified By Customer  SENSOR Magnum (SPDT) M6 Magnum (SPST) M7 Magnum (SPDT) M10 Magnum 2 (SPDT) M12 MagPAC 2 (SPDT) W/ LED INDICATION M13
9044 Aluminum NEMA 4, 4X CSA  	ANSI YELLOW (Inherently Hazardous) AY 	90° Rotation  B3 T		
9468 Engineered Resin NEMA 4, 4X Haz. Loc. Nonincendive Class I, Groups A, B, C, D Class II, Groups F, G Division 2 Only, FM, CSA   	ANSI GREEN (Liquid-Low Hazard) AG 	90° Rotation  B5		
9479 Aluminum Haz. Loc. NEMA 4, 4X, 7, 9 Class I, Groups C, D Class II, Groups E, F, G Division 1 & 2 Class I, Grps. A, B, Div. 2, UL, CSA   	ANSI BLUE (Gas-Low Hazard) AB 	180° Rotation  B7		
	ANSI RED (Fire Quenching) AR 	180° Rotation  B9		

For Eliminator configuration on 9479 and 9468 enclosures, prefix part numbers with the letter (E).
For flat cover (no Beacon) suffix part number with the letter (F). **Example: 9044F**

Westlock reserves the right to change product designs and specifications without notice, and is not responsible for errors and omissions.